

WAC LIGHTING

STRUT

Recessed Trimless Channels

Fixture Type: _____
 Catalog Number: _____
 Project: _____
 Location: _____

ORDER NUMBER

System	Model	Length		Finish	
S2	CL04-FE	4 ft Trimless Recessed Feed End	Required Power Feed Connected Power Unit Required	BK Black WT White	
	CL08-FE	8 ft Trimless Recessed Feed End			
	CL12-FE	12 ft Trimless Recessed Feed End			

Example: **S2CL04-FE-BK** Each section comes with two matching end caps and may be cut at end run.

System	Model	Length		Finish	
S2	CL04	4 ft Trimless Recessed Channel	To extend channel runs after feed end	BK Black WT White	
	CL08	8 ft Trimless Recessed Channel			
	CL12	12 ft Trimless Recessed Channel			

Example: **S2CL08-BK** Each section comes with two matching end caps and may be cut at end run.

PRODUCT DESCRIPTION

The only lighting, power, and control system complete with lighting elements designed for discriminating performance. Configure STRUT for your retail, restaurant, commercial office, or residential lighting plan without custom lead times - get exactly what you want, when you want it.

FEATURES

- Heavy duty grade 48VDC trimless recessed channel with data bus.
- Operating Current: Max circuit is rated 12A
- Magnetic infrastructure allows you to slide elements within the STRUT and adjust lighting effects while powered
- Black copper busways for power and communications
- 5 Year warranty

SPECIFICATIONS

Construction: Extruded aluminum with solid copper alloy bus bars
Input: 48 VDC
Mounting: Recessed into drywall, Can be mounted on ceiling or wall vertically or horizontally
Finish: Electrostatically Powder Coated Black
Standards: UL, cUL, Dry Location Listed, IC

FINISHES



Black

LINE DRAWING

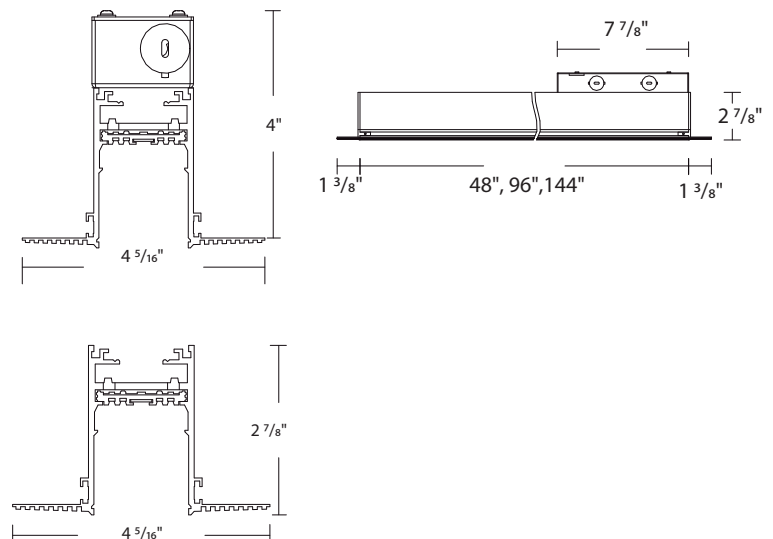

WAC LIGHTING

STRUT

Recessed Trimless Channels

Fixture Type: _____

Catalog Number: _____









Project: _____

Location: _____





CHANNEL COVER

	Channel Cover 8ft 8ft length may be field cut, Suitable for top or bottom channel coverage.	S2C-COV08	BK WT	Black White
--	---	------------------	------------------------	----------------

CONNECTORS

	Accessories	System	Finish	
	I Connector Joins two sections of channel with electrical continuity	S2CSR-I	BK	Black
	Dead I Connector Joins two sections of channel without electrical continuity	S2C-ID	BK	Black
	End Cap Additional end cap	S2CL-EC	BK	Black
	L Connector Use to join two sections 90°.	S2CL-L	BK	Black
	T Connector Use to join three sections.	S2CL-T	BK	Black
	X Connector Use to join four channel sections	S2CL-X	BK	Black
	Inside Corner Joins ceiling to wall sections	S2CL-IC	BK	Black
	Outside Corner Joins wall to wall sections	S2CL-OC	BK	Black

SUSPENSION HARDWARE

	Accessories	System	Finish	
	Mount Clip Support recessed channel with 1/4 - 20 threaded rod (rod by others)	S2CR-CLIP	BK	Black
	Cable Suspension Suspend channel from plenum ceiling. Includes 96in aircraft cable; may be field cut	S2C-C96	BK NI	Black Nickel
	Stem Suspension Suspend channel from plenum ceiling. Includes two 48in stem; may be field cut	S2C-S96	BK WT	Black White
	Suspension Loop Mechanical loop Supports up to 15 lb	S2C-LOOP	BK	Black

WAC LIGHTING

STRUT

Recessed Trimless Channels

BUILD IT

CHOOSE YOUR CHANNELS AND CONNECTORS

- Power feed from feed end channel to energize your run.
- Support Strut with screws into rear blocking, 1/4"-20 tie rod (by others), or stem or aircraft cables to plenum ceiling. Minimum two supports per 4ft section.
Minimum three supports per 8ft and 12ft section.
- For patterns, choose L, T, X, or corners.

Note: STRUT is field cut at end of run. For patterns and custom length channels, consult factory.

CHOOSE YOUR ELEMENTS

- Refer to element specifications to appropriately select elements.
- Total the wattage of the system.

CHOOSE YOUR CONNECTED POWER UNIT (CPU)

- Select remote mount CPU.
- Select appropriate wattage based on total system wattage.

Note: recommended sizing up as feasible for increased system capability.

ACCESSORIZE

- Add channel covers, lenses, or glare control accessories as desired.

Fixture Type: _____
 Catalog Number: _____
 Project: _____
 Location: _____

A	S2CL08-FE	8FT FEED END RECESSED TRIMLESS CHANNEL	G	S2CL-OC	RECESSED TRIMLESS OUTSIDE CORNER
B	S2CL04	4FT RECESSED TRIMLESS CHANNEL	H	S2CR-CLIP	1/4"-20 TIE ROD MOUNTING CLIP
C	S2CL08	8FT RECESSED TRIMLESS CHANNEL	I	S2C-C96	CABLE SUSPENSION
D	S2CSR-I	I CONNECTOR	J	S2C-S96	STEM SUSPENSION
E	S2CL-IC	RECESSED TRIMLESS INSIDE CORNER	K	S2CPU-R600-S-BK	REMOTE CPU
F	S2CL-L	RECESSED TRIMLESS L CONNECTOR	L	BY OTHERS	FIELD WIRING TO CPU

